

Data Sheet



Article number: 604132032030

Description: Taper bored timing belt pulley
HTD 32 8M 30 TL 1615

Measures

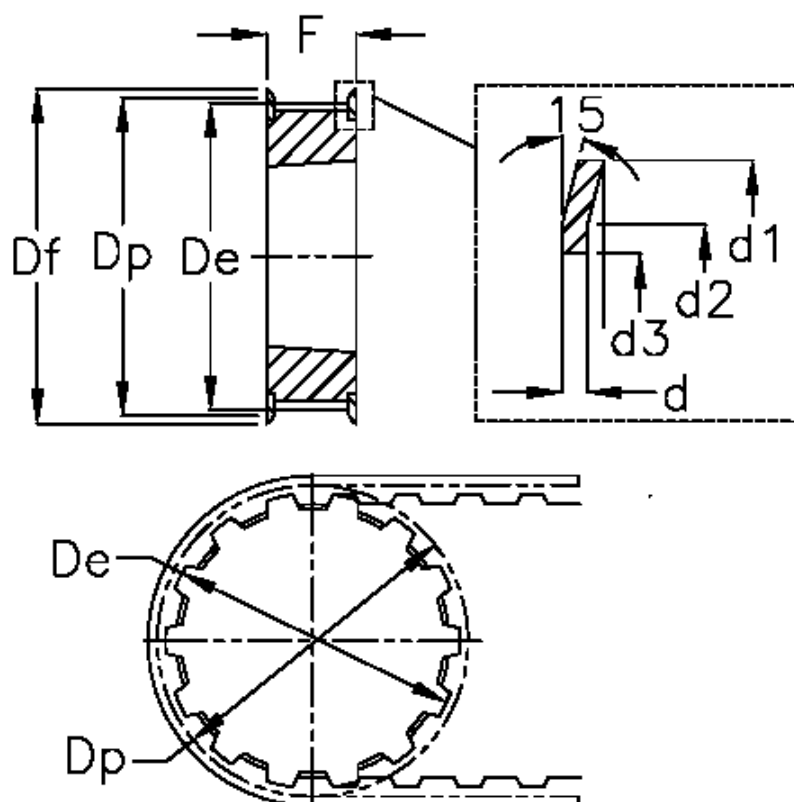

$d = 1.5$	Flange type = F30
$d1 = 87$	For bushing = 1615
$d2 = 82.5$	Max bore = 42
$d3 = 72$	S = 38
$De = 80.16$	Tooth number = 32
$Df = 87$	Type = 8M
$Dp = 81.49$	Weight = 0.59
$F = 38$	Width = 30